



LUBRIFICATION - LUBRIFICAZIONE
SCHMIERUNG - LUBRICATION - SMØRING
SMEREN - KENES - MAZANI - VOITELU - SMERESANA
SMAROWANIE - СМАЗЫВАНИЕ
LUBRIFICAÇÃO - LUBRIFIERE



SAE 75W-90
API GL-5

Huile synthétique
Olio sintetico
Synthetisches Öl
Synthetic oil

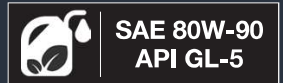

SAE 80W-90
API GL-5

Huile minérale
Olio minerale
Mineralöl
Mineral oil

KF0001TL_16
10/2023





SELECT



SAE 80W-90
API GL-5

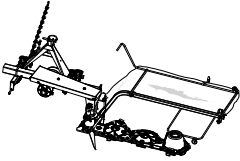

GMD33

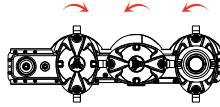

1,30 L
(0.34 US gal)



0,20 L
(0.05 US gal)

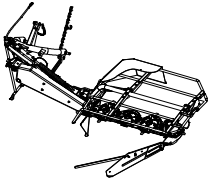

GMD44

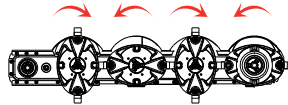

1,75 L
(0.46 US gal)

0,25 L
(0.06 US gal)

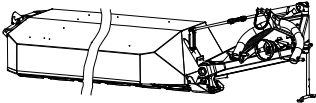

GMD55

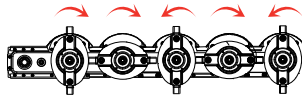

2,00 L
(0.52 US gal)

0,25 L
(0.06 US gal)

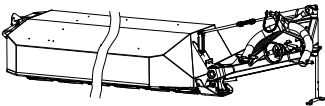

GMD66

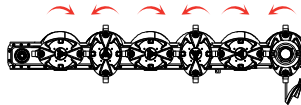

2,25 L
(0.59 US gal)

0,25 L
(0.06 US gal)

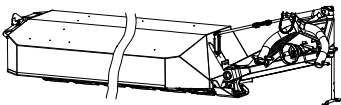

GMD77 HD

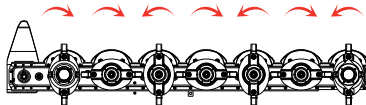

2,25 L
(0.59 US gal)

0,25 L
(0.06 US gal)



GMD16 - GMD20 GMD24 - GMD28

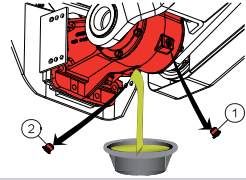

0,25 L
(0.07 US gal)

0,25 L
(0.07 US gal)

0,45 L
(0.12 US gal)

0,45 L
(0.12 US gal)

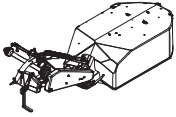

GMD16

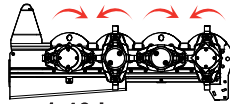

1,40 L
(0.37 US gal)

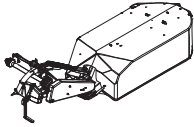

GMD20

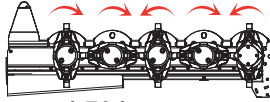

1,70 L
(0.45 US gal)

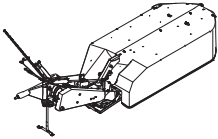

GMD24

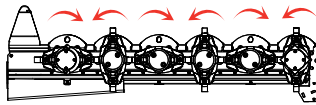

2,00 L
(0.53 US gal)

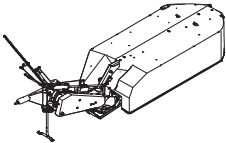

GMD28

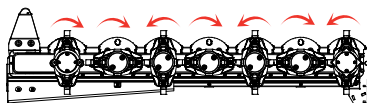

2,00 L
(0.53 US gal)



GMD100 - GMD100 GII



SAE 80W-90
API GL-5



GMD400 / GMD 400 HD

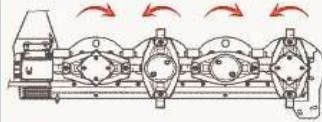

1,40 L
(0.36 US gal)



0,25 L
(0.06 US gal)



GMD500 / 500 S / 500 S HD

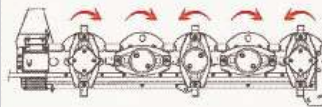

1,70 L
(0.44 US gal)

0,25 L
(0.06 US gal)



GMD600 / 600 GII / 600 GII HD

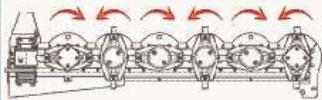

2,00 L
(0.52 US gal)

0,45 L
(0.11 US gal)



GMD700 / 700 GII / 700 GII HD

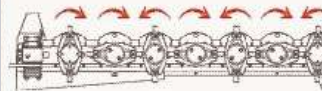

2,00 L
(0.52 US gal)

0,45 L
(0.11 US gal)



GMD800 GII / 800 GII HD

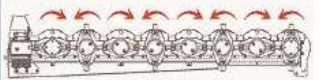

2,25 L
(0.59 US gal)

0,45 L
(0.11 US gal)

GMD240 - GMD280 GMD310 - GMD350



SAE 80W-90
API GL-5

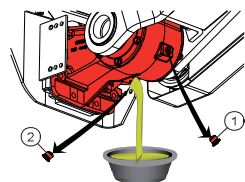
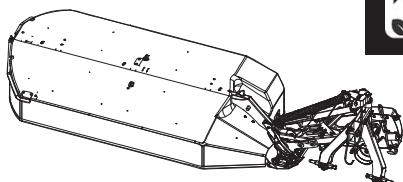

GMD240

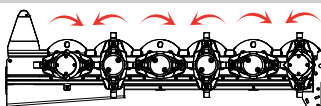

2,00 L
(0.53 US gal)

0,50 L
(0.13 US gal)

GMD280

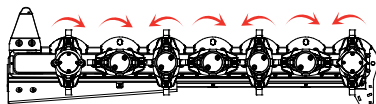

2,00 L
(0.53 US gal)

0,50 L
(0.13 US gal)

GMD310

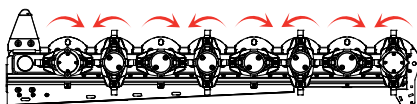

2,25 L
(0.59 US gal)

0,50 L
(0.13 US gal)

GMD350

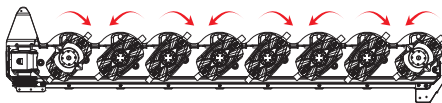

4,50 L
(1.18 US gal)



SAE 80W-90
API GL-5

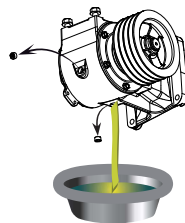

0,50 L
(0.13 US gal)

FC883



SAE 80W-90
API GL-5

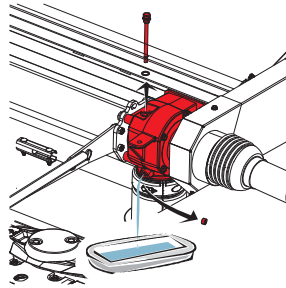

0,70 L x 2
(0.18 US gal)

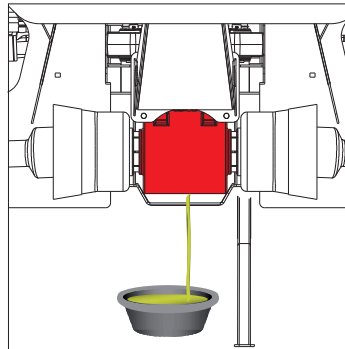

4,00 L
(1.05 US gal)

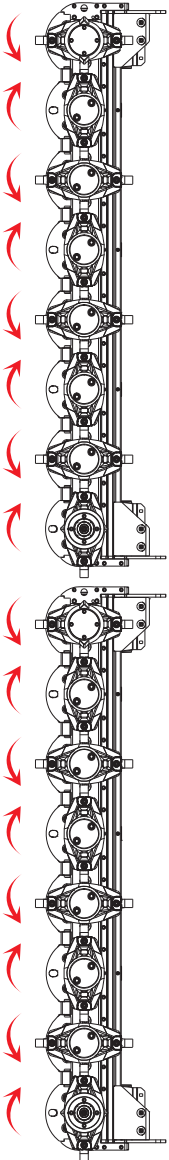

2,25 L x 2
(0.59 US gal)



GMD285 GMD315 - GMD355

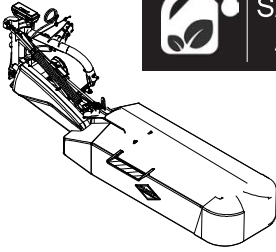

 SAE 80W-90
API GL-5

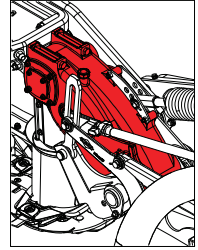

FC813 - FC813 R



SAE 80W-90
API GL-5

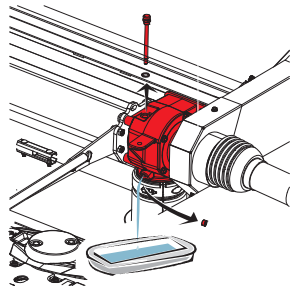

0,60 L x 2
(0.15 US gal)

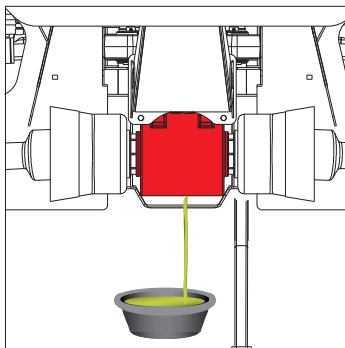

4,00 L
(1.05 US gal)

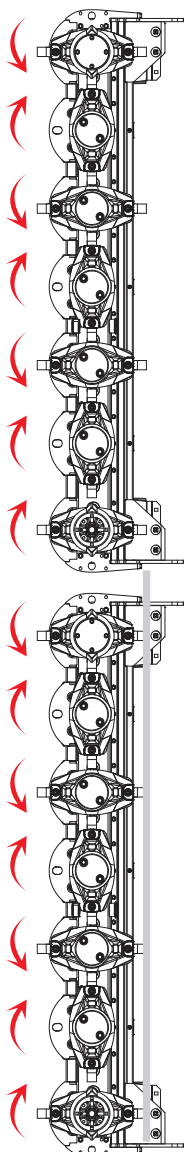

2,00 L x 2
(0.52 US gal)



GMD280 F - GMD310 F

 SAE 80W-90
API GL-5

A 0001 > A 1333:

 SAE 80W-90
API GL-5

A 1334 > :

 SAE 75W-90
API GL-5

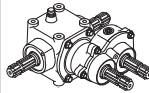
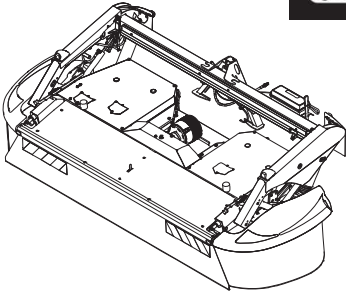

540 /
1000min⁻¹

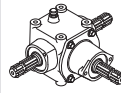

1000min⁻¹



GMD280 F

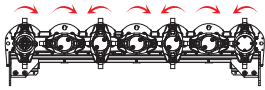

2,00 L
(0.52 US gal)

0,60 L
(0.15 US gal)

0,50 L
(0.13 US gal)

0,50 L
(0.13 US gal)

GMD310 F

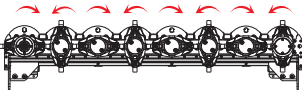

2,25 L
(0.59 US gal)

0,60 L
(0.15 US gal)

0,50 L
(0.13 US gal)

0,50 L
(0.13 US gal)

FC280 F



SAE 80W-90
API GL-5



540 /
1000min⁻¹

1000min⁻¹

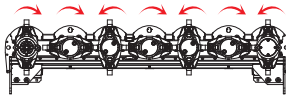

2,00 L
(0.52 US gal)

0,60 L
(0.15 US gal)

0,50 L
(0.13 US gal)



FC280 F

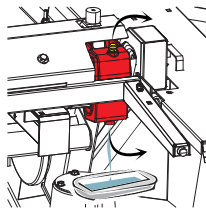

0,40 L
(0.11 US gal)

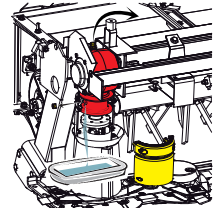

0,40 L
(0.11 US gal)



KF0001TL_16
10/2023

